

## The Effect of Orientation of Vortex Generators on Aerodynamic Drag Reduction in Cars

Fazalul Rahman C<sup>1</sup>, Iswarya Thiyagarajan<sup>1</sup>  
<sup>1</sup>DSI Technologies Pvt. Ltd., Technopark Campus, India  
<sup>1</sup>Asst. Prof., Aeronautical Eng., Dept, IARE, India

**Abstract:-** One of the main reasons for the aerodynamic drag in automotive vehicles is the flow separation near the vehicle's rear end. To delay this flow separation, vortex generators are used in recent vehicles. The vortex generators are commonly used in aircrafts to prevent flow separation. Even though vortex generators themselves create drag, but they also reduce drag by delaying flow separation at downstream. The overall effect of vortex generators is more beneficial and proved by experimentation. The effect depends on the shape, size and orientation of vortex generators. Hence optimized shape with proper orientation is essential for getting better results. This paper presents the effect of vortex generators at different orientation to the flow field and the mechanism by which these effects takes place.

**Keywords:** -Aerodynamic Drag, Drag Reduction, Flow separation, Orientation of Vortex Generator.

### I. INTRODUCTION

To improve the efficiency of vehicles, our concern is to minimize the usage of fuel. In automobile industry, drag reduction plays an important role to perceive this task. A car is very much constrained to have an aerodynamically bluff body due to its engine, passenger accommodation and baggage needs. Hence these shapes are accompanied by flow separation at the rear end of the vehicle. The aerodynamic bluffness of a car body can be expressed by its drag coefficient which is generally between 0.2 and 0.5, while the least bluff body like an aerofoil have a drag coefficient less than even 0.1. Fig.1 represents the fluid flow over cars.

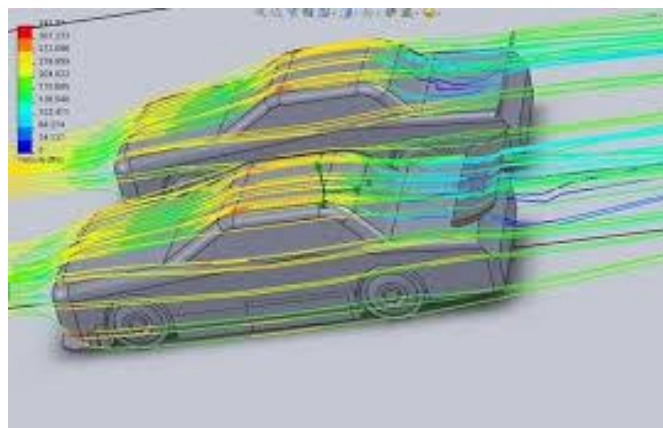

Fig.1 Fluid flow over cars

While considering the fluid flow over a car, the flow separation mechanism is of main concern. Fig.2 represents the planar view of the car and its velocity profile at the boundary layer.

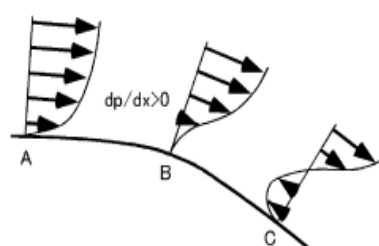

Fig. 2 Velocity profile at roof of a car without VG

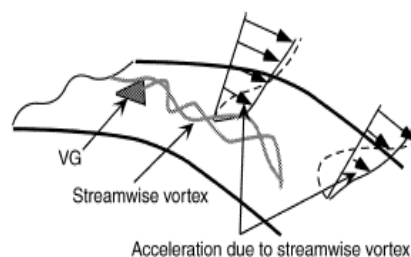

Fig.3 Flow around Vortex generator

At point A in the figure, momentum of the boundary layer is prevailing over the pressure gradient ( $dp/dx$ ). The pressure gradient at this point is favorable pressure gradient ( $dp/dx < 0$ ).

As we go further from point A, the height starts progressively lowering and the flow starts to get expanded. This causes the downstream pressure to rise, which in turn creates reverse force acting against the main flow. At Point B, where the pressure gradient and the momentum of the boundary layer are balanced, the flow gets separated.

At Point C, reverse flow occurs. It is because as we go further from point B to C the pressure gradient dominates over the momentum of the flow. The pressure gradient at this point is adverse pressure gradient ( $dp/dx > 0$ ) [1].

A concept of vortex generators (VGs) is introduced to extend the AB distance shown in Fig.2. The purpose of adding VGs is to supply the momentum from upstream flow having larger momentum to downstream flow having smaller momentum by stream wise vortices generated from VGs located just before the separation point, as shown in Fig.3 [2]. This allows the separation point to shift further downstream which helps to reduce the size of vortices formed at the rear end of cars. Hence, the drag acting on cars are reduced.

Though, the VGs create drag by itself, they also reduce drag by delaying flow separation at downstream. The overall effect of vortex generators is more beneficial compared to its demerit of creating drag by itself. But we need an optimized size for vortex generator with proper orientation to the flow field. The Effect of its orientation to the flow field is very much crucial in reduction of drag.

The previous works on drag reduction in cars have discussed the importance of having optimized shape and size in vortex generators which favors the delaying of flow separation [3].

The purpose of this paper is to introduce an idea for achieving maximum efficiency for an optimized vortex generator with different orientation and we compare its effect without vortex generator.

#### IV. CFD ANALYSIS

We have analyzed the backstep flow to provide some resistance to the fluid flow over cars by using a conceptual rectangular model. The aim of the analysis is to visualize the effectiveness of vortex generator on vehicles at different orientation and we have undergone four different cases for this purpose. Analysis is done by using ANSYS 15.0(Fluent) software.

First case is a rectangular model without vortex generator to compare the extend up to which a vortex generator can reduce the size of the vortices i.e., the extend up to which the drag can be reduced. Second, third and fourth cases are rectangular model with vortex generators kept straight, convergent and divergent respectively to the flow field. These cases will help to determine which orientation will be more effective to reduce drag by using vortex generator

##### 1.1 Design Modeling

###### 1.1.1 Case 1

Fig.4 represents the rectangular model. The dimension of this box is 2.74 m in length and 0.877 m in height which is approximately equivalent to normal cars from front mirror top to the rear end. But for analysis we have scaled to cm from m due to graphical issues.

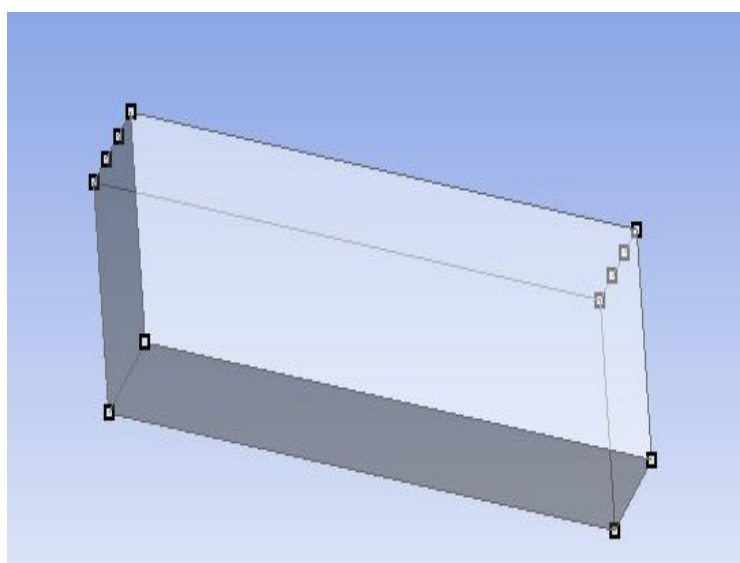

**Fig.4 A rectangular Model**

## 1.2 Case 2

Fig.5 represents the vortex generator of 0.2m length, 0.09m height and 0.032m thickness. It is having a half cylinder of radius 0.016m for the smooth flow over the vehicle which is sliced by the flat surface top of the rectangular block. It is kept at a distance of  $1/10^{\text{th}}$  of the length of the block at the roof end. Two vortex generators are used for the analysis .Fig.6 represents the car with straight vortex generator to the flow field.

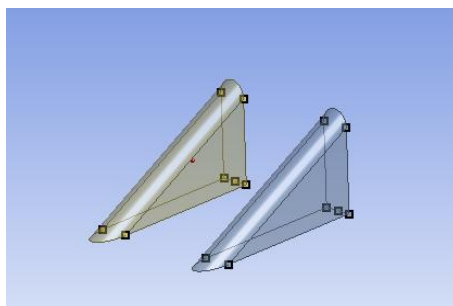

Fig.5 Vortex Generator



Fig.6 Top view of car with vortex generator kept straight to the flow field

### 1.2.1 Case 3 and Case 4

The two vortex generators inclined at an angle of 10 degree in a convergent and divergent form to the flow field are represented in case 3 and 4 respectively. Refer Fig.7 and Fig.8

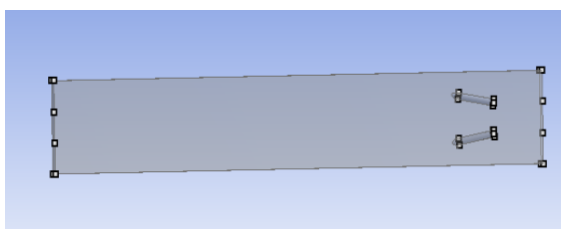

Fig.7 Top view of car with vortex generator kept converging to the flow field

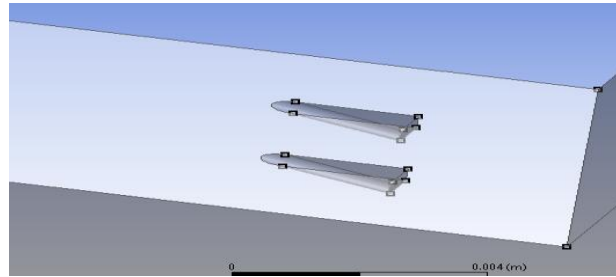

Fig.8 Top view of car with vortex generator kept diverging to the flow field

### 1.2.2 Flow field above the car

We design a flow field which is the most important part where we analyze the effect of vortex generator on cars. The flow field domain is taken a dimension of  $3L-3H$  by comparing the dimensions of the block. For obtaining the flow field, we create a block of dimension  $4L-4H$  and same thickness as that of the rectangular block. Boolean subtraction (Isolating a flow field from the entire domain) is done to isolate the flow field.

A similar flow domain of smaller size near the vicinity of the car is created to give finer mesh to the region just above the surface since more concentration on that domain is needed as the vortex size and our main focus is on that domain only. Refer Fig.9 and 10.



**Fig.9 Void of vortex generator in the flow field**

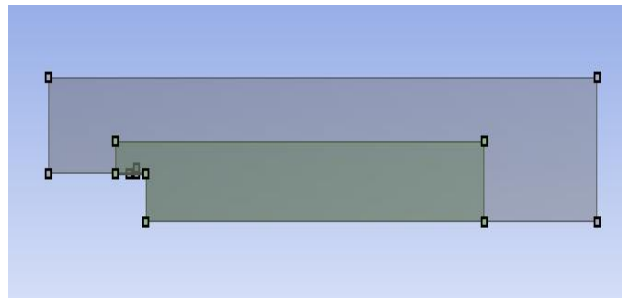

**Fig.10 The smaller block represents the domain in flow field where we give finer mesh**

### 1.3 Meshing

The general mesh sizing is given as follows:

Min size: 1.49e-4mm, max face size: 1.00mm, max size: 1.00mm

The number of elements for each case is represented in Table 1.

S.No	Case Number	Number of Elements
1	Case 1	729085
2	Case 2	846054
3	Case 3	847441
4	Case 4	839219

**Table 1 Number of elements in each case**

#### 2.2.1 Case 1

For capturing the boundary layer with proper inflation, 10 layers are given based on total thickness with a maximum thickness of 1mm and 1.2 growth rate. Body sizing with element size of .45mm is applied to the brown colored domain represented in Fig.10. The mesh obtained is satisfied with the quality parameters. The orthogonal quality of the mesh is above .01 and the skewness is below .95.

#### 2.2.2 Case 2, case 3 and case 4

Two types of inflations are given for these cases. First type of inflation is the same as case 1. Second type of inflation is with 10 layers based on total thickness with a maximum thickness of .25mm and 1.2 growth rate near the vortex generator region (Refer Fig 11 and Fig 12). The overall mesh of the flow domain is represented in Fig.13.

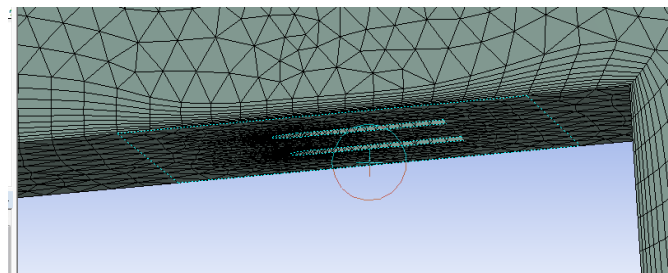

**Fig.11 Mesh transition from 1mm max thickness to .25mm max thickness**

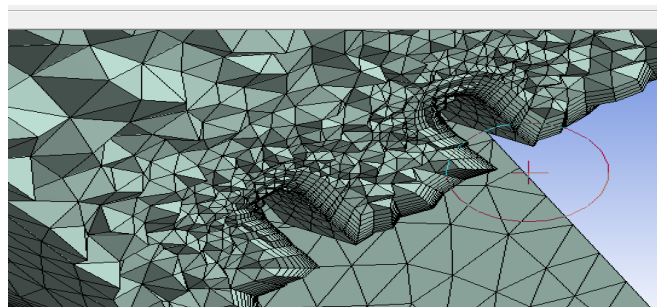

Fig.12 Mesh cross section of the flow field just above the vortex generator

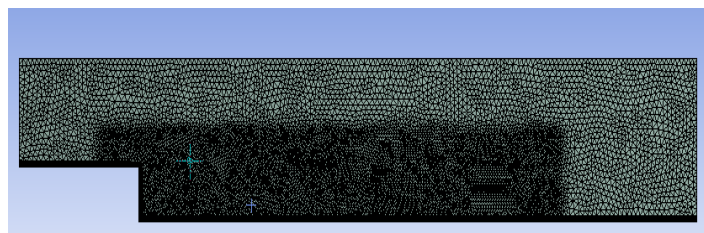

Fig.13 Overall mesh of the flow field

### 2.3 Solving the CFD problem

The Analysis for this steady case is done by using pressure based Solver. The turbulent model used is Realizable kinetic energy-epsilon model for the experiment. This model is more accurate for rapidly strained/swirling flows. This type of model is recommended for flows with boundary layers under strong adverse  $\Delta p$ , separation and recirculation.

A velocity of 50 m/s is applied at the inlet and the outlet is pressure outlet(Refer Fig.14 and 15). The Turbulent specification is based on Intensity and viscosity ratio. Turbulent intensity is the ratio of the fluctuations in velocity to the mean velocity and viscosity ratio is the ratio of turbulent viscosity to the laminar viscosity. For external flows the viscosity ratio ranges from 1 to 10. [4]

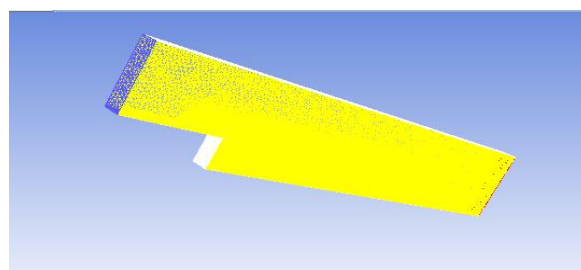

Fig.14 Blue color represents the inlet

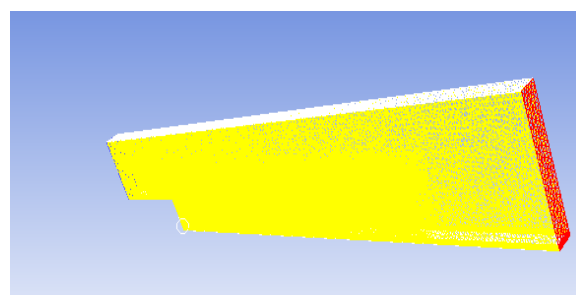

Fig.15 Red color represents the outlet

The two symmetric faces and all other faces except the inlet, outlet, symmetry and the face that shown in Fig.16 is given no slip condition. Since the face shown in Fig.16 is interacting with the same phase (air), we are applying some specified shear to this face with 0.5 roughness constant.

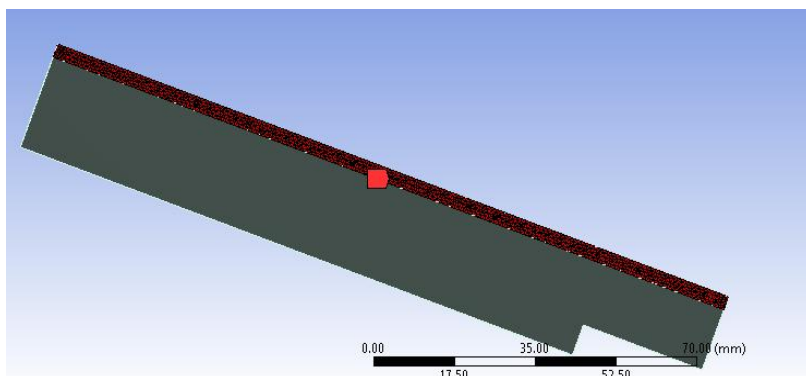

Fig.16 Red color showing the face where we apply specified shear.

The scheme used is Simple in pressure based solver. The gradient is least squared cell based. The pressure and momentum are second order. Turbulent kinetic energy and turbulent dissipation rate is based on first order upwind. In analysis, the continuity and spatial coordinate velocity residuals are monitored. For the convergence of physics, we monitor the mass flow rate at the outlet.

### III. RESULTS AND DISCUSSION

Velocity contour plots are determined in the analysis. Vortex size is correctly determined through velocity vector plots. The length of the vortices and maximum velocity attained for each case after convergence is represented in the Table 2 given below.

S.No	Case Number	Size of the Vortex(in m)	Maximum Velocity attained(in m/s)
1	Case 1	5.96	51.11
2	Case2	5.95	56.5
3	Case3	5.85	63.3
4	Case4	5.77	61

Table 2 Length of the vortices and Maximum velocity for the cases

#### Case 1

The Maximum Velocity obtained is almost the same as that of inlet velocity. The Vortex size of this case helps to compare and determine the extend up to which the vortex generator's will reduce the drag. The Velocity Contours and Vortex formed is represented in the Fig17 and 18.

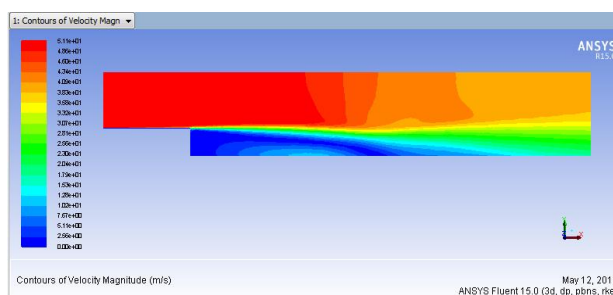

Fig17 Velocity contours for case1

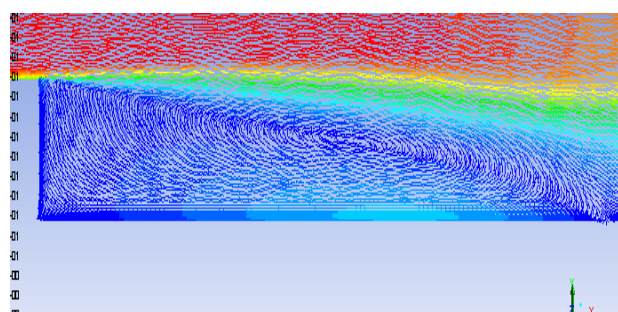
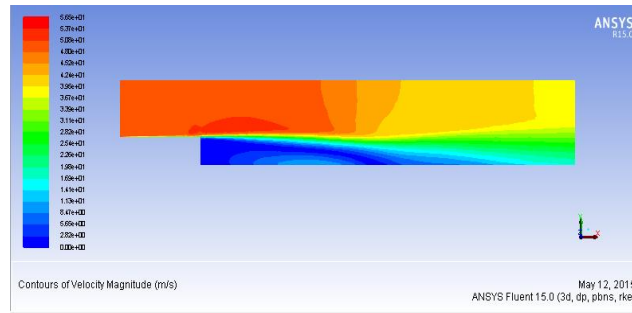

Fig18 Vortices formed for case1

**Case 2**

The Vortex size of this case helps to compare and determine the extend up to which the orientation of vortex generator's will reduce the drag compared to straight Vortex generator with respect to flow field. The length of the Vortex is almost the same as that of the vortex formed without vortex generator. The Velocity Contours and Vortex formed is represented in the Fig19 and 20.



**Fig19 Velocity contours for case2**

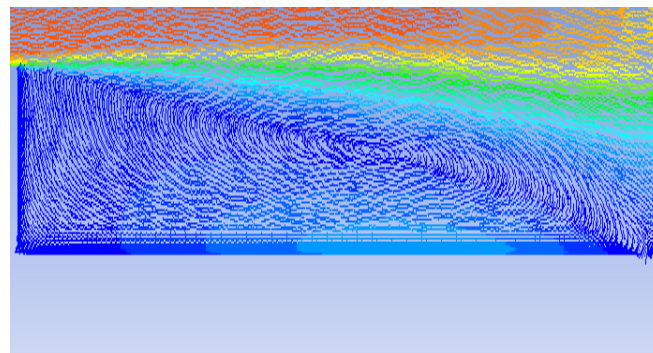

**Fig20 Vortices formed for case2**

**Case 3**

The Vortex size of this case is .1 m less compared to Case 2. It highlight's the extend up to which the convergent vortex generator to the flow field will reduce the drag compared to straight vortex generator to the flow field. The Velocity Contours and Vortex formed is represented in the Fig21 and 22.

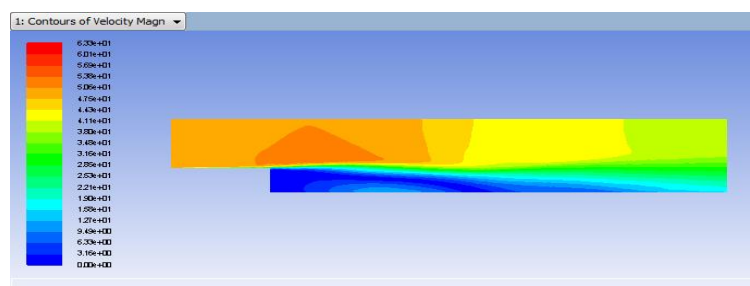

**Fig21 Velocity contours for case3**

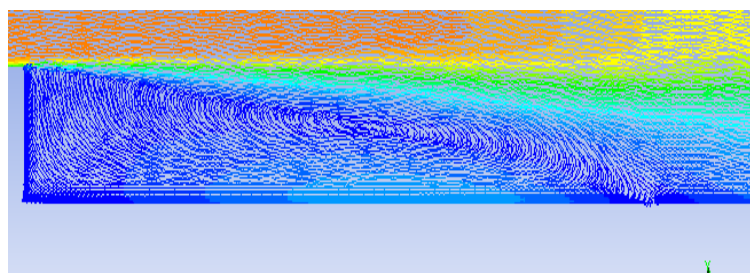

**Fig22 Vortices formed for case3**

**Case 4**

The Vortex size of this case is the minimum among all the cases. Hence the Vortex generator kept divergent to the flow field is the most effective method among other cases in drag reduction. The Velocity Contours and Vortex formed is represented in the Fig23 and 24.

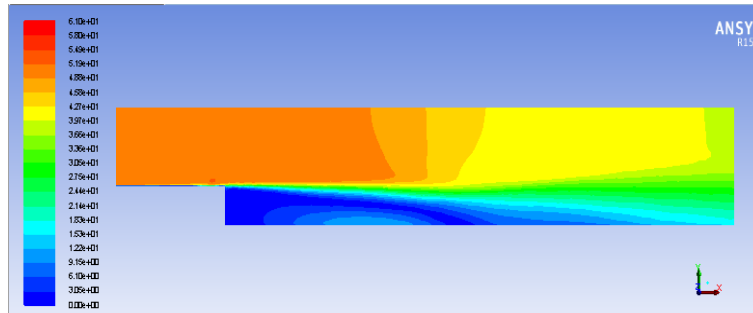

**Fig23 Velocity contours for case4**

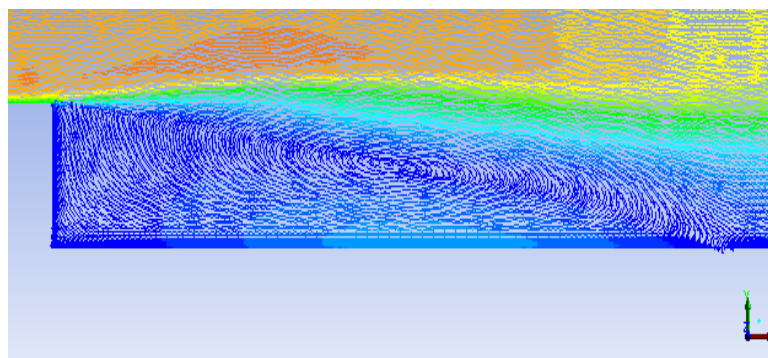

**Fig24 Vortices formed for case4**

**IV. CONCLUSION**

The vortex generator kept divergent to the flow field is the most effective approach for drag reduction in cars. It is followed by the vortex generator kept convergent to the flow field, followed by the straight vortex generator. The car with straight vortex generator and without vortex generator is giving almost the same effect, so it is advantageous to have some inclination to the vortex generator with respect to flow field for increasing the effectiveness of the vortex generator.

**REFERENCES**

- [1]. John D. Anderson, Fundamentals of Aerospace third Edition, McGraw-Hill series in Aeronautical and Aerospace Engineering,(1984,1991)
- [2]. Hucho, W.H., Aerodynamics of Road Vehicles, Fourth Edition, SAE International 1998.
- [3]. Masaru Koike, Tsunehisa Naga yoshi and Naoki Hamamoto, Research on Aerodynamic Drag Reduction by Vortex generators „Mitsubishi Motors technical review, No.16,2004.
- [4]. Ansys 15.0 reference manual.